

 Double sided alu snap-frame profile - 32 mm - with mitred corners and two anti-reflex APET frontpanels. Allows posters to be displayed both in- and outdoor. Paste frame profile on the inside of the shopwindow and the alu backplate on the outside. Posters to be replaced only from the inside.

 Doppelseitiger Alu Klapprahmen - 32 mm Profile - mit Ecken auf Gehrung. Mit 2 Stück APET Frontscheiben geliefert. Wird auf der Fensterscheibe innen geklebt - der Kontrarahmen auf der Aussenseite. Die 2 Plakate werden Innen getauscht. Von sowohl Innen als auch Aussen sichtbar.

 Dobbeltsidet klappamme med 32 mm aluprofil og geringshjørner. Leveres med 2 stk. APET antirefleks frontplader. Profilen klæbes på ruden indvendig og alu-bagprofiler klæbes på udvendig. De to plakater vises både inden- og udenørs, men skiftes indendørs.



Model	Article	Poster size	Visible size	Color	Total W x H	Package size and weight	Pallet size and quantity
242	<b>4602</b>	42 x 59,4 cm A2	40 x 57,4 cm	Alu/silver	46,2 x 63,6 cm	46 x 67 x 3,1 cm 1,7 kg	80 x 120 x 220 cm 200 pcs.
242	<b>4604</b>	50 x 70 cm	48 x 68 cm	Alu/silver	54,2 x 74,2 cm	56 x 76 x 3,1 cm 2,2 kg	80 x 120 x 220 cm 150 pcs.
242	<b>4603</b>	59,4 x 84,1 cm A1	57,4 x 82,1 cm	Alu/silver	63,6 x 88,3 cm	66 x 91 x 3,1 cm 2,6 kg	80 x 120 x 220 cm 120 pcs.
242	<b>4605</b>	70 x 100 cm	68 x 98 cm	Alu/silver	74,2 x 104,2 cm	76 x 106 x 3,1 cm 3,3 kg	80 x 120 x 220 cm 100 pcs.

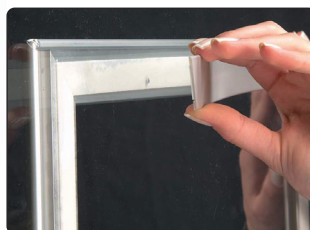
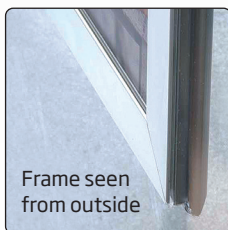
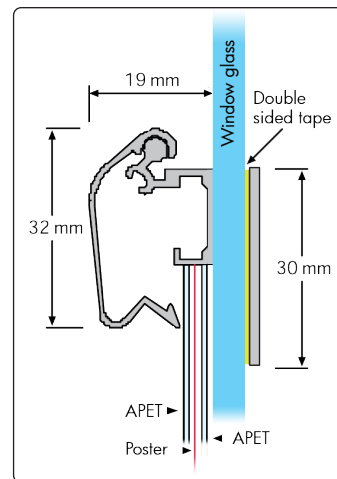
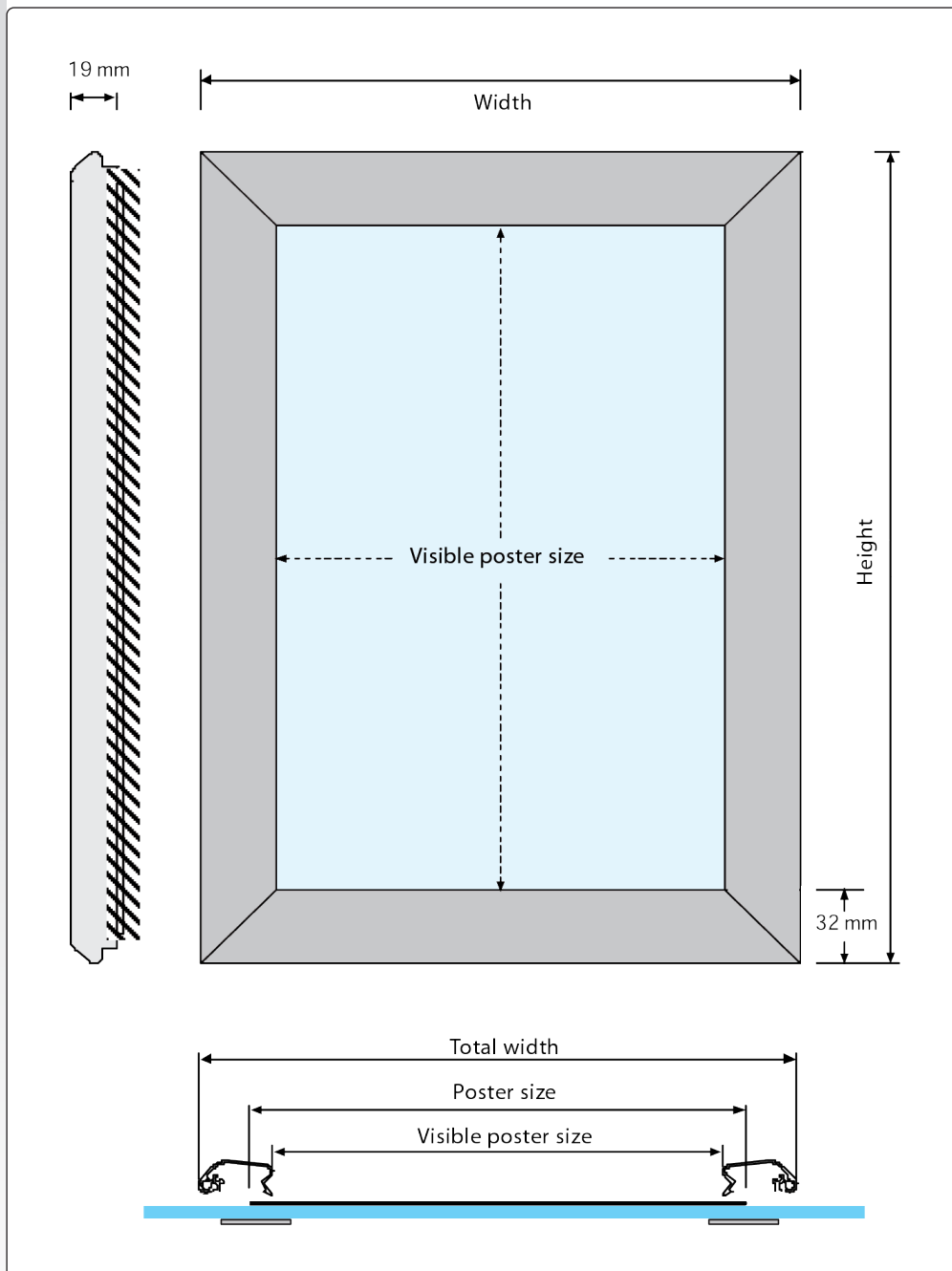

- Take off the yellow protection of the double sided tape along the sides of the frame and post it on the window.
- Kleben Sie den Rahmen mit dem dahinter befindlichen doppelseitigen Band an das Fensterglas.

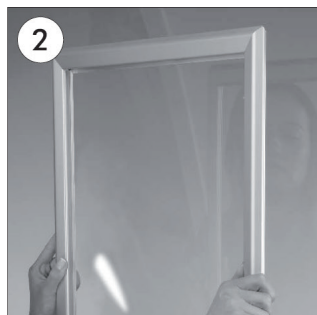

- Take off the yellow protection of the double sided tape along the decorative backing profiles. Post these bars on the other side of the window.
- En fernen Sie die Schutzfolie am Klebeband der anderen 4 Contra-Profilen. Kleben Sie diese Contra- Profile von der Gegenseite des Fenstersglases kantengleich mit dem Rahmen.

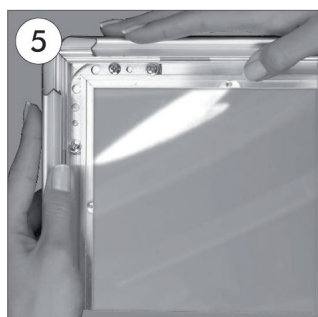
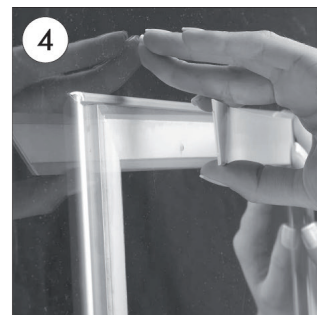

- Open all profiles.
- Alle Profile in der Pfeilrichtung öffnen.

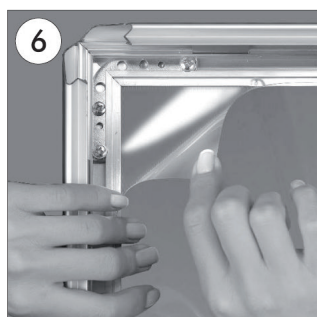

- Take-off the anti-reflex cover.
- Antireflex -Schutzfolie abheben.

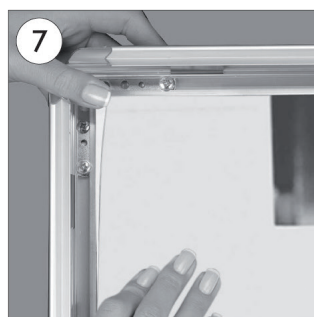

- Place in the poster.
- Poster einlegen.

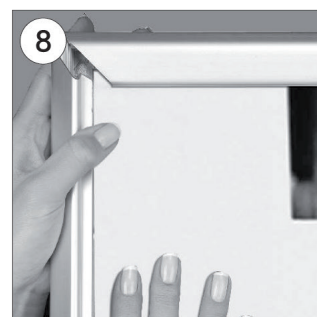

- After placing the cover back on the poster, close the profiles.
- Antireflex-Schutzfolie auf Poster legen und die Seitenprofile in Pfeilrichtung zuklappen.

**CAUTION/VORSICHT:**

- For the best application of adhesive tape to window, the appiled surface must be dry, clean & flat.
- Um das beste Ergebnis der Klebung am Fenster zu erzielen,achten Sie bitte auf die Trockenheit und Sauberkeit der angewandten Fläche

